

TS/DEM

EDA-00780-V1		INDICE	NBRE DE COUCHE : 4
		-	EP. DU CUIVRE : 35u
DESS	CEGELEC JMC		EP. DU CIRCUIT : 16/10e
DATE	13/09/2004		MATIERE DU CI : EPOXY

SERIGRAPHIE TOP

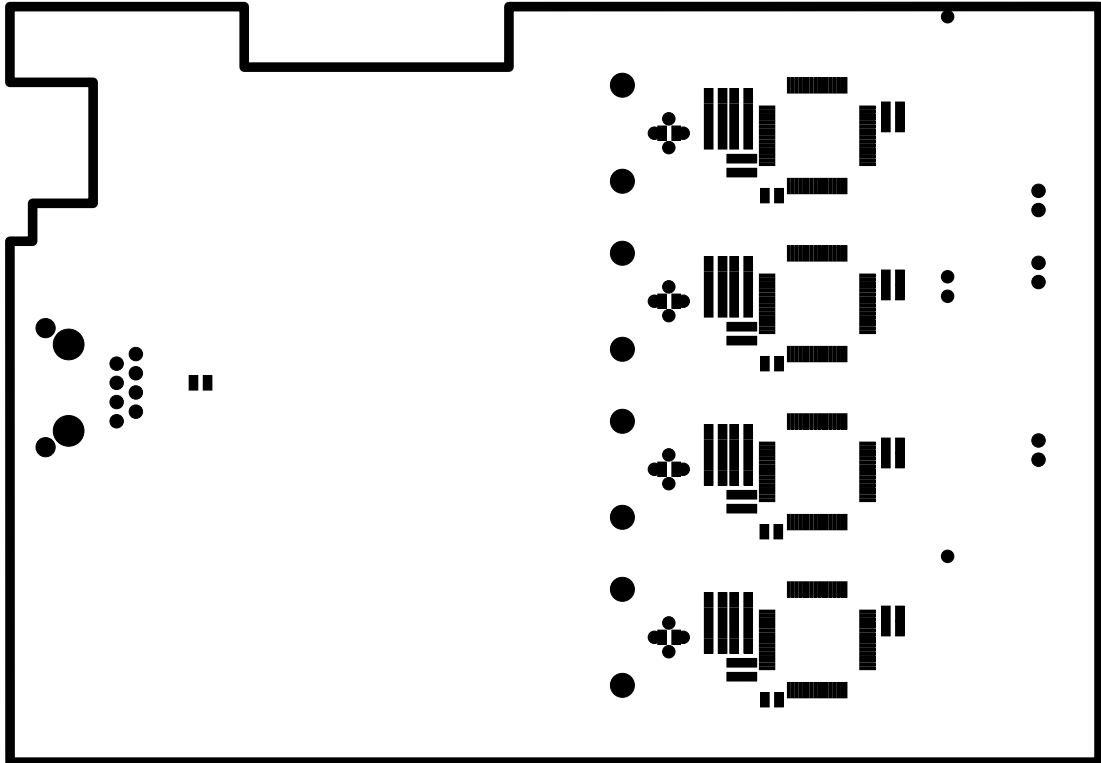

EDA-00780-V1		INDICE -	NBRE DE COUCHE : 4
DESS	CEGELEC JMC		EP. DU CUIVRE : 35u
DATE	13/09/2004		EP. DU CIRCUIT : 16/10e
			MATIERE DU CI : EPOXY

LAQUE ARRET DE SOUDURE C-SIDE

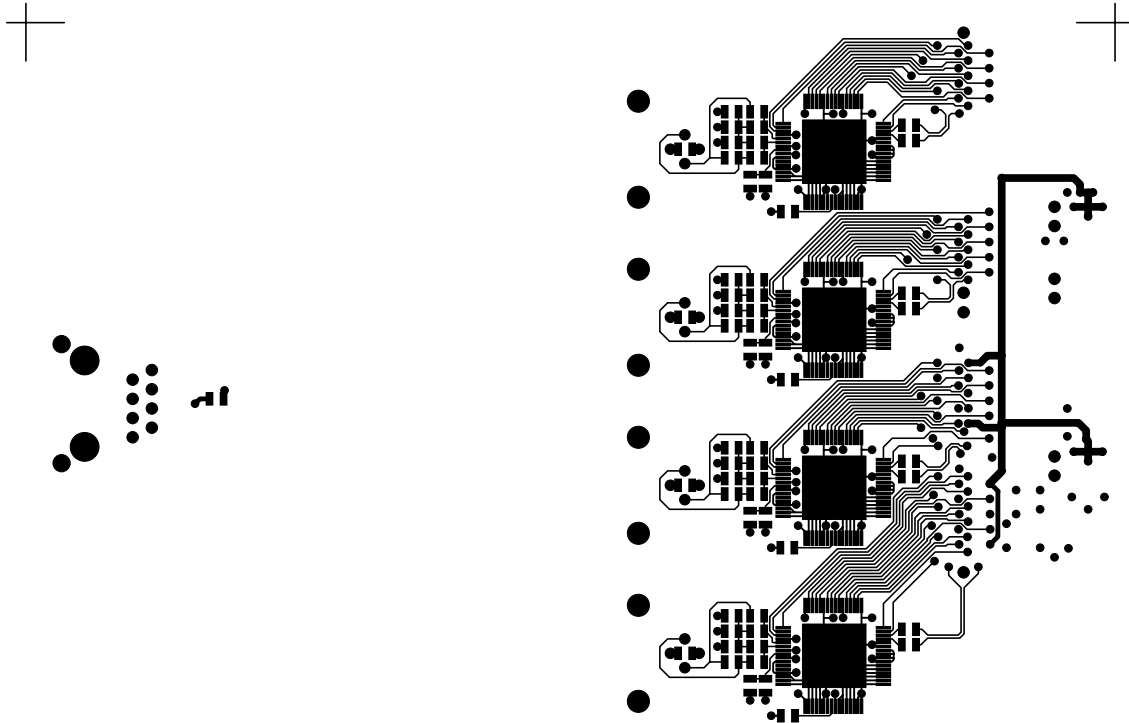

TS/DEM

EDA-00780-V1		INDICE	NBRE DE COUCHE : 4
		-	EP. DU CUIVRE : 35u
DESS	CEGELEC JMC		EP. DU CIRCUIT : 16/10e
DATE	13/09/2004		MATIERE DU CI : EPOXY

FACE COMPOSANTS

1			
---	--	--	--

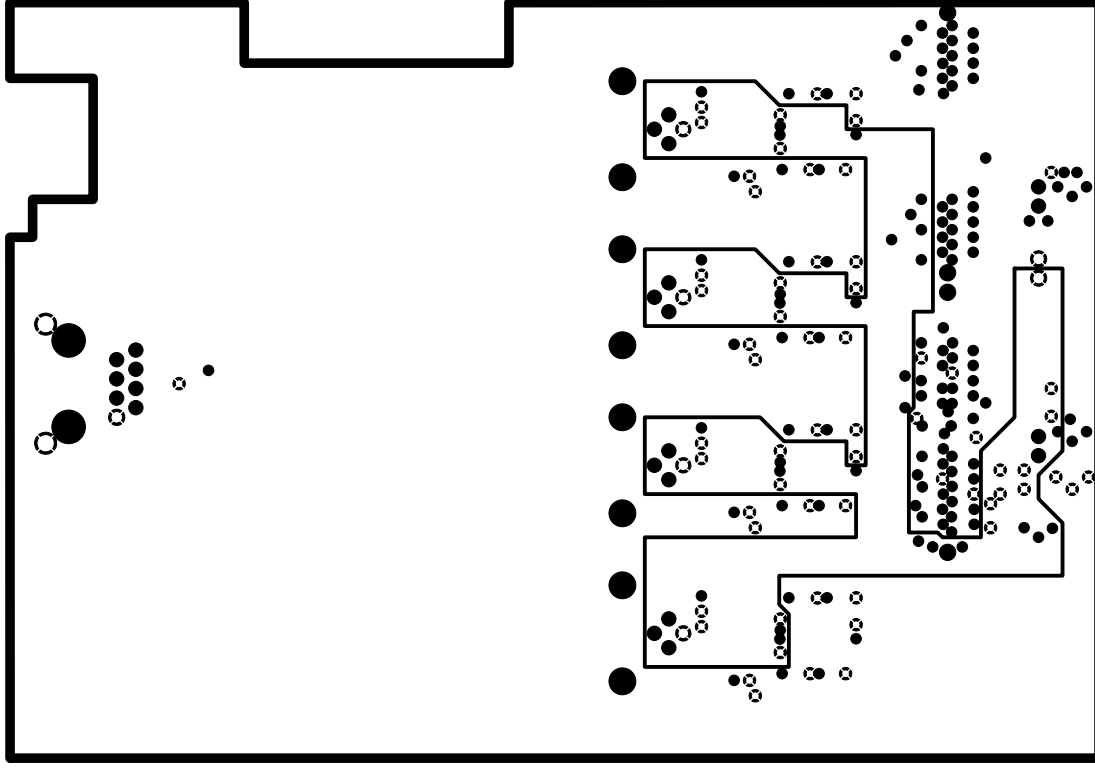

DATE	13\08\2004	DESIGN	CEGELEC JMC	INDEX	-	EDA-00780-V1	
MATIERE DU CI	EPOXY	EP. DU CIRCUIT	18\10e	EP. DU CUIVRE	32u	NBRE DE COUCHE	4



PLAN GND

2		
---	--	--

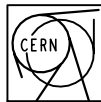
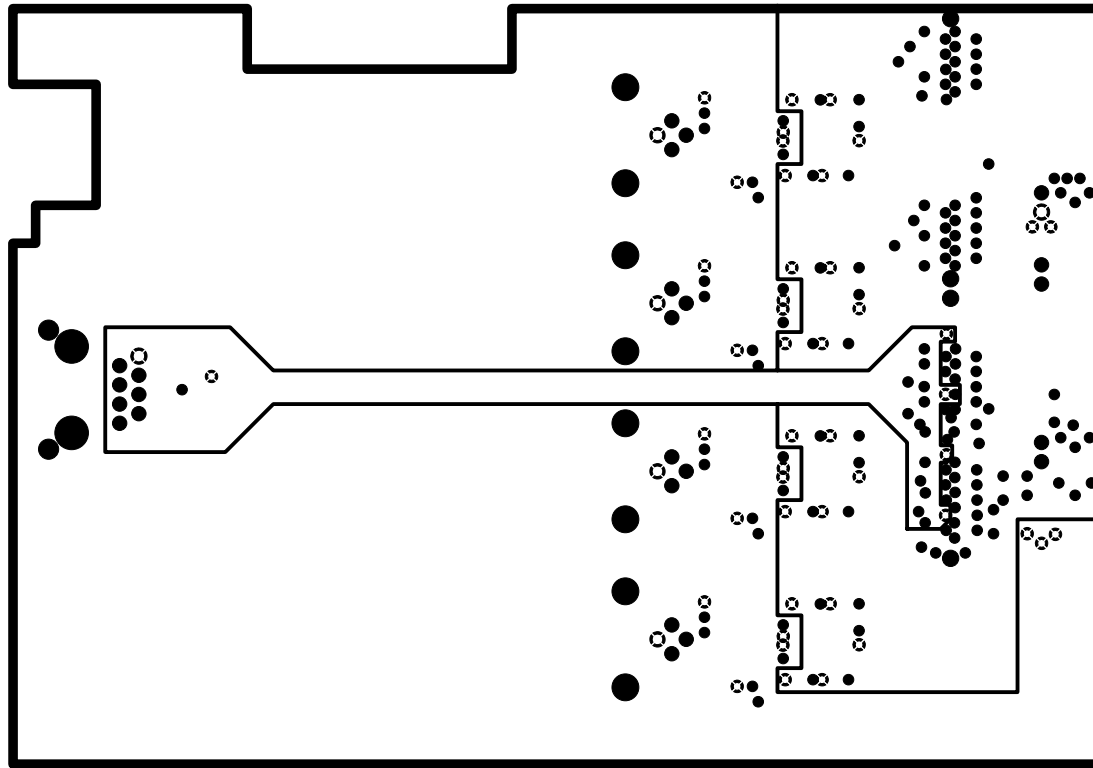

TS/DEM

EDA-00780-V1		INDICE	NBRE DE COUCHE : 4
		-	EP. DU CUIVRE : 35u
DESS	CEGELEC JMC		EP. DU CIRCUIT : 16/10e
DATE	13/09/2004		MATIERE DU CI : EPOXY

PLAN VDD/P2V5/P3V3

		3	
--	--	---	--

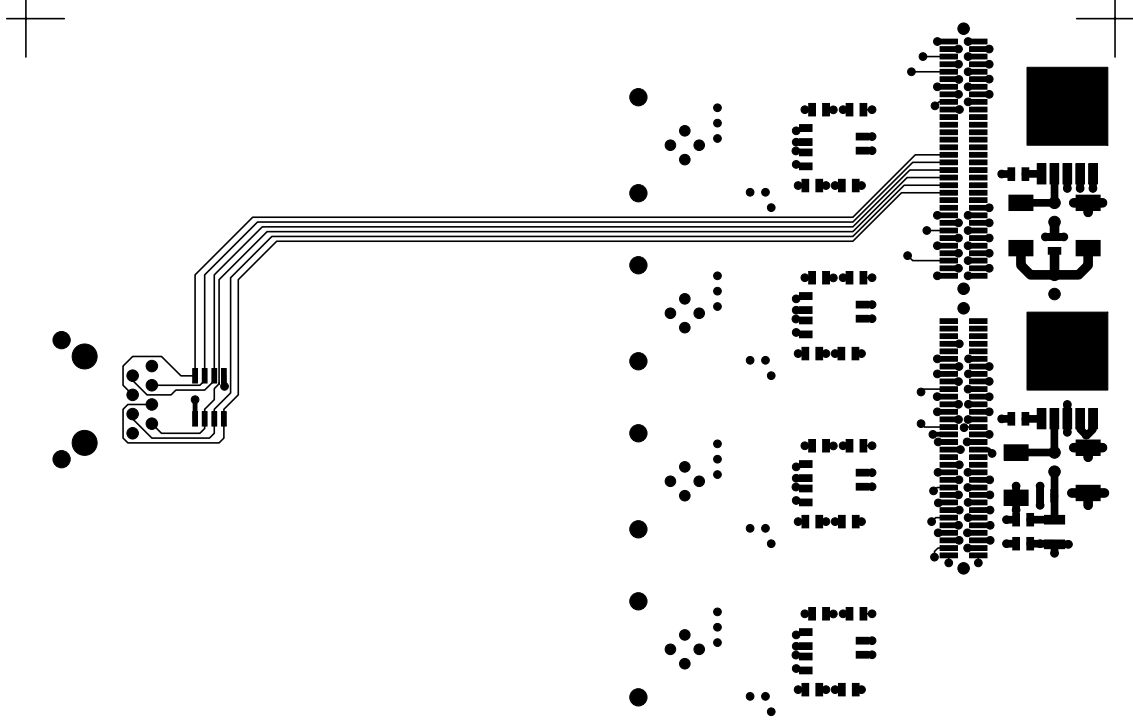

DATE		DESIGN	FACE SONDREES	
13\08\2004	CEGELEC JMC	EDA-00780-V1	4	
MATIERE DU CI : EPOXY	EP. DU CIRCUIT : 16\10e	EP. DU CUIVRE : 35u	INDICE	
		NBRE DE COUCHE : 4		



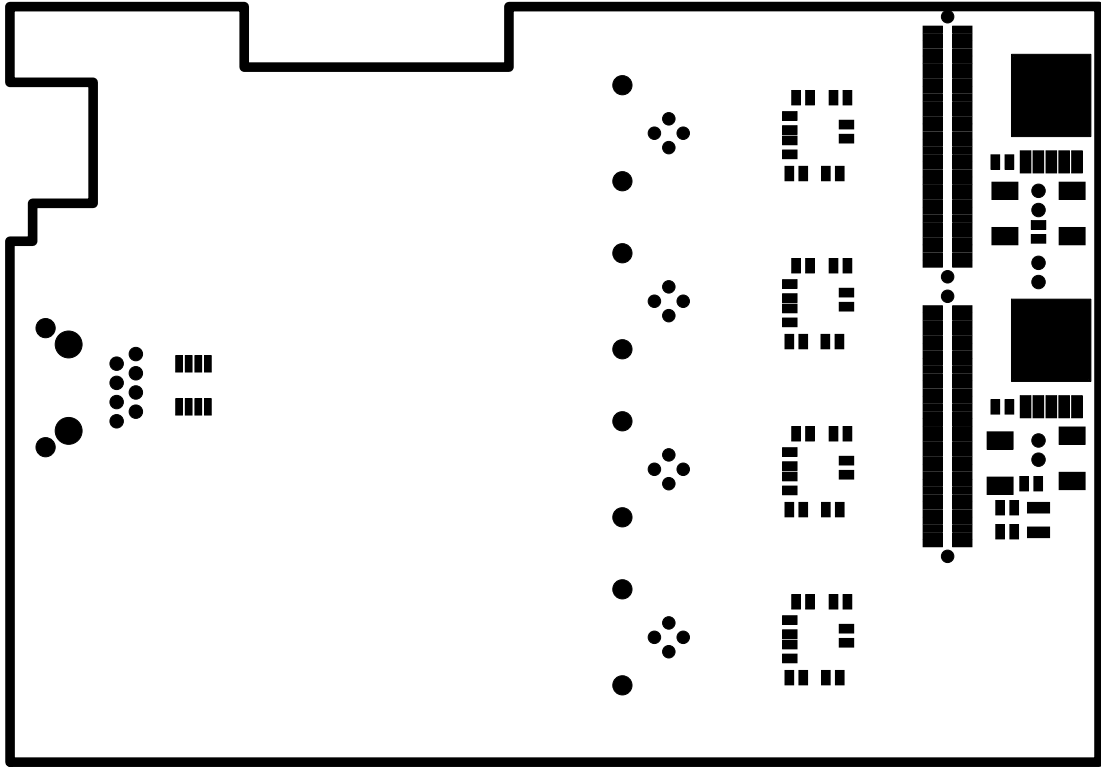

DATE	13\08\2004	MATIERE DU CI	: EPOXY
DESS	CEGELEC JMC	EP. DU CIRCUIT	: 18\10e
	EDA-00780-V1	EP. DU CUIVRE	: 32u
		INDICE	-
		NBRE DE COUCHE	: 4



LAOUE ARRET DE SONDURE W-SIDE

12VDEM

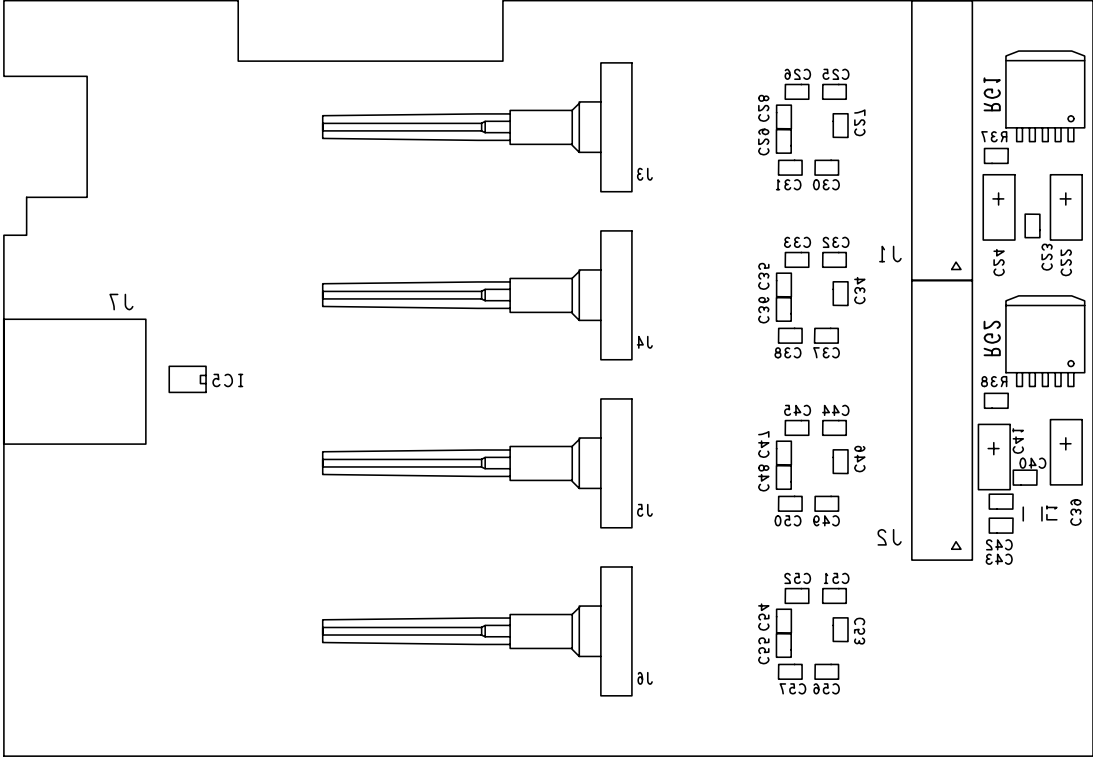

DATE	13\08\2004	DESIGN	CEGELEC JMC	EDS	EDA-00780-V1	INDICE	-
MATIERE DU CI	EPOXY	EP. DU CIRCUIT	18\10e	EP. DU CUIVRE	32n	NBRE DE COUCHE	4



2ERIGRAPHIE BOTTOM

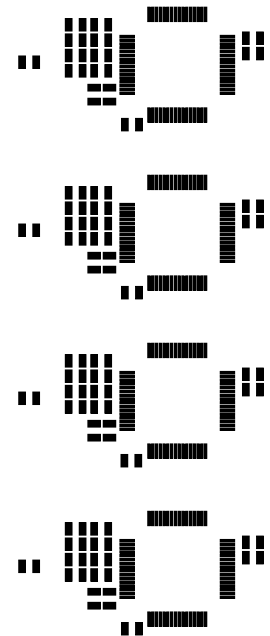

..



 TS/DEM	EDA-00780-V1		INDICE -	NBRE DE COUCHE : 4
	DESS	CEGELEC JMC		EP. DU CUIVRE : 35u
	DATE	13/09/2004		EP. DU CIRCUIT : 16/10e
				MATIERE DU CI : EPOXY



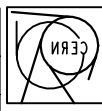

DATE	13\08\2004	MATIERE DU CI	EPOXY
DESS	CEGELEC JMC	EP. DU CIRCUIT	18\10e
	EDA-00780-V1	EP. DU CUIVRE	32n
		INDICE	-
		NBRE DE COUCHE	4

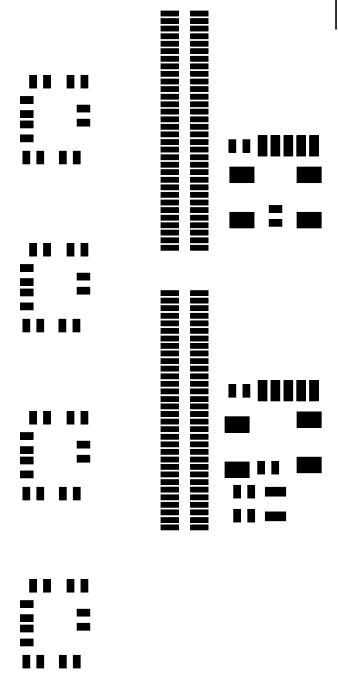

12VDEM

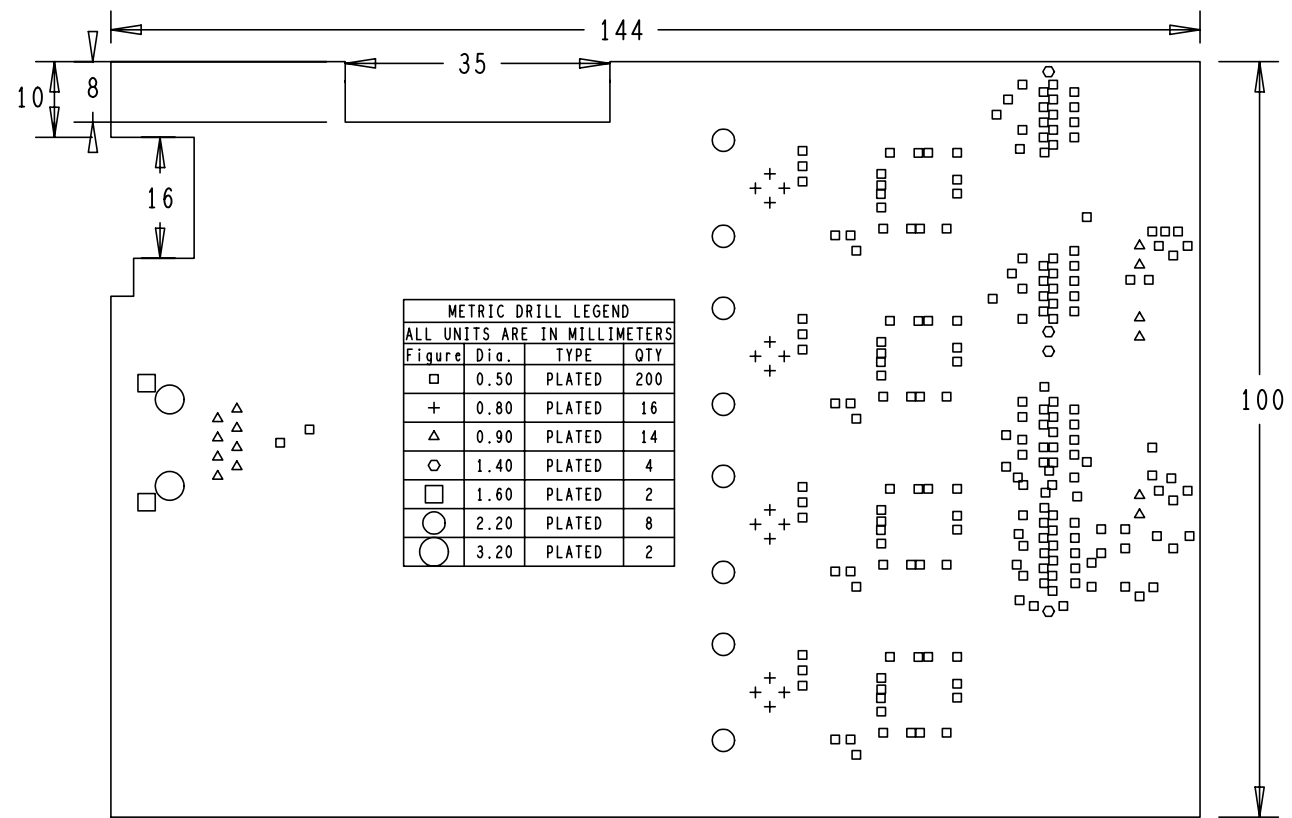



 TS/DEM	EDA-00780-V1		INDICE -	NBRE DE COUCHE : 4
	DESS	CEGELEC JMC		EP. DU CUIVRE : 35u
	DATE	13/09/2004		EP. DU CIRCUIT : 16/10e
				MATIERE DU CI : EPOXY